

MAR300 series

AIR UNITS (R. UNIT)



mindman



Symbol

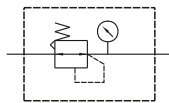

Specification

Model	MAR300	
Bore No.	8A	10A
Port size	1/4	3/8
Medium	Air	
Max. operating pressure	1 MPa	
Proof pressure	1.5 MPa	
Effective orifice	32 mm ²	34 mm ²
Regulated pressure range	0.05~0.85 MPa	
Ambient temperature	-5~+60°C (No freezing)	
Attachment	Bracket	
Option	Pressure gauge (PG-40)	
Weight	250g	

Order example

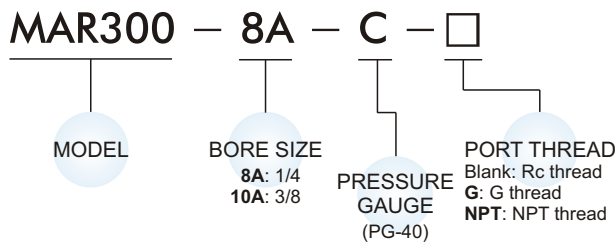

Flow feature

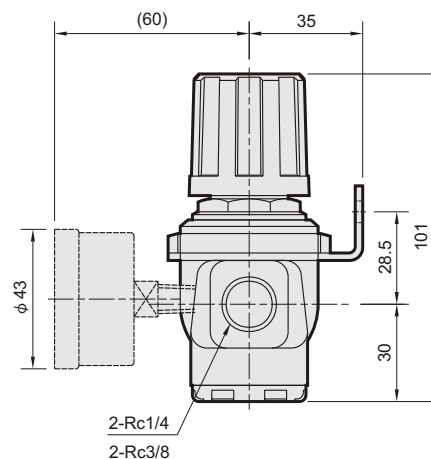
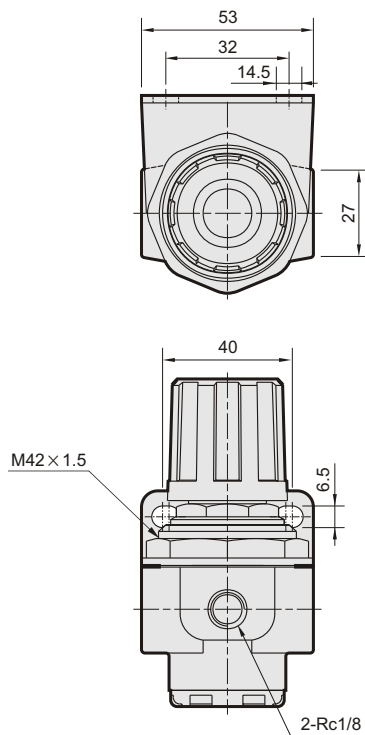
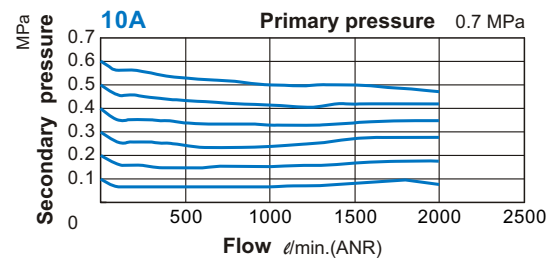
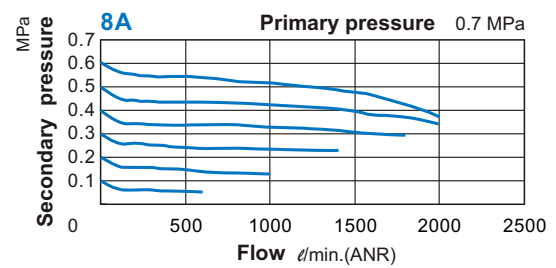

mindman